

International Conference

The many dimensions of poverty

Brasilia, Brazil – 29-31 August 2005
Carlton Hotel

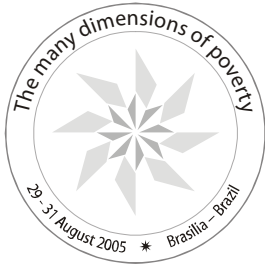

Using an asset index to assess trends in poverty in seven Sub-Saharan African countries

Conference paper

Frikkie Booysen
University of the Free State

Servaas van der Berg
University of Stellenbosch

Ronelle Burger
University of Stellenbosch

Michael von Maltitz
University of the Free State

Gideon du Rand
University of Stellenbosch, South Africa

DFID Department for
International
Development



ipea
Institute for Applied
Economic Research

INTERNATIONAL
Poverty
centre
United Nations Development Programme



Using an asset index to assess trends in poverty in seven Sub-Saharan African countries¹

Frikkie Booysen*, Servaas van der Berg[#], Ronelle Burger[#], Michael von Maltitz* & Gideon du Rand[#]

*University of the Free State, [#]University of Stellenbosch

Paper presented at conference on *Multidimensional Poverty* hosted by the International Poverty Centre of the United Nations Development Programme (UNDP)
29-31 August, Brasilia, Brazil

ABSTRACT

This paper aims to analyse trends in poverty in seven African countries using an asset index constructed from data from comparable, nationally representative surveys using multiple correspondence analysis. Improvements in the asset index are largely driven by progress in the accumulation of private assets, while access to public services has deteriorated. Continued efforts at the expansion of access to public services, particularly in rural areas, are thus required. Overall poverty has declined in five of the seven countries. The trends in urban and rural poverty for the most part mirror these trends in overall poverty. These results, however, should be interpreted with caution, given the various conceptual and methodological limitations of the asset index approach to poverty analysis.

Keywords: poverty, asset index, multiple correspondence analysis, Africa

JEL codes: I32, I38, O55

¹ This work is funded by the Poverty and Economic Policy Network of the Canadian International Development Research Centre (IDRC) under grant number 03-RG-10176. This paper represents an abridged version of the draft final research report presented at the annual PEP meeting that took place in Colombo, Sri Lanka in June 2005. As this is a draft, readers should not cite this paper without prior authorisation of the authors.

There are different approaches to the measurement of poverty. In essence, one can distinguish between the conventional approach to the measurement of poverty, which is money-metric and uses income and/or expenditure data, and a number of alternative approaches, such as for instance those that employ various other socio-economic indicators to measure poverty. Of these alternative or so-called multidimensional approaches to the measurement of poverty, the asset index approach applied to data from Demographic and Health Surveys (DHS) has gained increasing popularity in recent years (Filmer and Pritchett, 1998; Sahn and Stifel, 2000; World Bank, 2000a). The aim of this paper is to analyse trends in poverty in seven African countries towards the end of the 20th century using an asset index constructed from data collected from nationally representative DHS surveys with the aid of multiple correspondence analysis.

The application in this paper of the asset index approach to the measurement of poverty is not unique. Sahn and Stifel (2000) for example employed DHS data in an analysis of poverty in nine African countries using an asset index, while Filmer and Pritchett (1998) analysed poverty in Indian states using a similar approach. Our effort, however, differs from these previous studies in two important respects. *Firstly*, and most importantly, we employ multiple correspondence analysis (MCA) rather than principal components analysis (PCA) to construct the asset index. This methodology is more appropriate as MCA was designed for the analysis of categorical variables and unlike PCA, which is appropriate for multivariate analysis of continuous variables, does not presume that indicator values are normally distributed. *Secondly*, we employ data from a number of more recent surveys compared to the datasets employed by the likes of Sahn and Stifel (2000), whom employs data for two years compared to our three periods, which allows conclusions regarding trends in poverty in African countries in the more recent past.

One can also argue that this paper is not unique, given that various estimates of the extent of poverty in these African countries have in fact been published. In the past decade, moreover, there has been a considerable expansion of our knowledge of poverty in Africa, following the increased availability of representative survey data on income and/or expenditure for a growing number of African countries. Yet, Sahn and Stifel (2000: 2123) maintain that, “in the vast majority of African countries, we remain unable to make inter-temporal comparisons of poverty” as a result of problems with the comparability of survey designs and the quality of price deflators. This suggests that there remains some scope for further work in this field. The results, derived with the aid of these alternative methodological approaches to the measurement of poverty can therefore be used to interrogate (and triangulate) our existing knowledge of trends in poverty in these countries based on more conventional methodological approaches.

This paper is structured as follows. Section 1 describes the data, while section 2 elaborates on the methodology employed in the construction of the asset index and in the poverty analysis. Section 3 reports on some descriptive analyses of the asset index, in particular its ability to discriminate adequately between households enjoying different levels of welfare. Sections 4 employ the asset index to assess poverty over time and space in these seven African countries. Section 5 concludes.

1. Data

More than seventy nationally representative Demographic and Health Surveys (DHS) have been conducted in more than fifty countries since 1984 (Sahn & Stifel, 2000: 2127), a

number that has increased since 2000 with various developing countries having conducted their first DHS or follow-up DHS surveys. One of the major strengths of these surveys is the standardisation of certain sections of the survey and the resulting comparability across specific questions. According to UNFPA (2002), the country coverage is biased so that lower- and middle-income countries where USAID concentrate its development efforts are more likely to be included. Larger countries and countries in need of programme assistance are also more likely to be surveyed.

Given the focus of our work on trends in poverty over time, only those Sub-Saharan African countries with at least three Demographic and Health Surveys between the late 1980s and early 2000s were selected for inclusion in the study. This allows us to track changes over time in poverty over a period of 10 to 15 years for 7 African countries: namely, Ghana, Kenya, Mali, Senegal, Tanzania, Zambia and Zimbabwe. Appendix A lists the sample sizes for each of the surveys and outlines the general characteristics of the DHS surveys conducted in these seven countries, e.g. the year of the survey, the sample sizes and the sample breakdown by gender and settlement area.

For the purpose of cross-country comparisons, surveys are numbered in the order in which they were completed (e.g. Ghana Period 1, 2 and 3), instead of using the year of the survey. The first period surveys all date from the period 1986-1992, the second from 1992-1996, and the third from 1997-2001. As would be required for meaningful comparisons between countries over time, the survey years for the three periods do not overlap. In the case of Tanzania and Zambia the first period-surveys were completed by March 1992, whilst the second period-survey in Senegal commenced in November 1992, but was only completed in August 1993.

For the DHS surveys conducted prior to 1990 (Ghana 1988, Kenya 1989, Mali 1987, Senegal 1986 and Zimbabwe 1988), the questions about asset ownership, access to public services, and housing characteristics were part of the individual questionnaire and were not asked as part of the household questionnaire as was the case for all the other surveys used in this paper. Responses to these questions in all cases were consistent across different individuals from the same household. Hence, the recode file for the individual-level data was collapsed into a household-level file by keeping the data for one individual from each household that was interviewed in the survey. The number of households in the collapsed data file represents 73% (Ghana), 66% (Kenya), 78% (Mali), 40% (Senegal), and 71% (Zimbabwe) respectively of the number of households sampled in the particular survey. The DHS only interviews certain individuals in each household (normally females or males aged 15-49 years). Hence, the number of households sampled in the survey exceeded the number of households in the collapsed data file. Households composed entirely of members who are below or above this age have thus been excluded. This raises the possibility that households represented in these five DHS surveys may be significantly different from households in the general population. This limitation should be borne in mind when comparing poverty reported for these surveys to that of successive periods.

Appendix B to this paper summarises select demographic and socio-economic characteristics of these seven African countries. The countries included in our sample range from relatively small in terms of population size (Senegal 9.8 million), to relative large (Tanzania 33.4 million). All countries were relatively poor, with gross national income per capita below US\$ 500 per capita – and thus ranked 159th or lower out of 208 countries in terms of gross national income per capita in the UNDP's Human Development Report

(UNDP, 2003). Also, these countries all implemented Structural Adjustment Programmes (SAPs) in the 1980s or early 1990s. Of this group of countries, only Zimbabwe has not embarked on the road of Poverty Reduction Strategy Programmes (PRSPs). With the exception of Kenya, the six other countries in the early 2000s had completed ‘full PRSPs’. The countries also differ significantly in terms of other important statistics related to development such as access to water and sanitation and expenditure on health and education.

2. Methodology

This section outlines the methodology employed in the construction of the asset index and the application of this measure of household welfare in poverty analysis.

2.1 Construction of the asset index

Traditionally, the DHS does not include questions on income and expenditure. None of the twenty-one country surveys analysed included a question on expenditure or income. As a result, it is not possible to employ the conventional approach to the measurement of poverty using these data. Following in the footsteps of Filmer and Pritchett (1998), Sahn and Stifel (2000) and Asselin (2002), we created a composite poverty indicator or asset index from a selection of variables from the DHS surveys.

Table 1: Variables included in and weights obtained from multiple correspondence analysis

Variable	Categories	Weights
Radio	Owns a radio	0.294
	Does not own a radio	-0.234
TV	Owns a TV	1.568
	Does not own a TV	-0.103
Fridge	Owns a fridge	1.630
	Does not own a fridge	-0.099
Bicycle	Owns a bicycle	0.022
	Does not own a bicycle	-0.006
Toilet	No toilet	-0.308
	Flush toilet	1.147
	Pit latrine	-0.087
	Other toilet facility	-0.129
Floor material	Earth floor	-0.270
	Cement floor	0.359
	Smart floor	1.830
	Other floor material	0.435
Water source	Piped water	0.877
	Public water	-0.037
	Well water	-0.229
	Surface water	-0.223
	Other source of water	-0.207

To ensure comparability across countries and time, only variables that appear in all of the 21 questionnaires and were phrased similarly could be included in the analysis. Table 1 lists the variables, with the categories for each variable noted in the second column. The

construction of the asset index was based on binary indicators on four household level assets, viz. the presence or absence of a radio, TV, fridge and bicycle, and categorical indicators on three variables, viz. type of toilet facilities and type of flooring (4 categories each) and main water source (5 categories). The fact that a relatively small number of variables or indicators (seven) are included in the analysis is the result of the fact that earlier surveys (i.e. those conducted in the late 1980s) included fewer questions and allowed for fewer responses than did subsequent surveys.² Understandably this reflects the development of the DHS survey over time rather than trends in asset ownership or access to public services *per se*.

This acts as a constraint, however, given our interest in trends in poverty over time because the resulting index can hardly be interpreted as a complete measure of well-being. It lacks the additional dimensions required (e.g. health, education, security) to differentiate it from monetary poverty. The asset index constructed here contains two types of assets: communal, public assets versus private income-associated assets. It may thus be more appropriate to consider the index as a correlate of monetary poverty. Asset indices are slow-moving compared to income and expenditure, as reflected in the survey data. (However, in some cases there are large fluctuations between time periods. For instance, in Tanzania the proportion of the population with bicycles jumps from 21.5% to 31.9% from Period 1 to period 2 while the proportion of the population with piped water declines from 8.6% to 3.1% between Period 2 and 3. It is unlikely that these trends could be due solely to changes in asset ownership or access to public services. It is more probable that the shifts are at least partly attributed to sampling design errors or other problems complicating comparability between surveys. The latter appears to be more likely because the large discontinuities are often concentrated in just one or two categories. These data reliability issues may be problematic for our analysis of trends in poverty over time, thus requiring that we interpret these results with due caution.) Important changes in the economic situation of many households may leave the asset indices virtually unchanged in the short to medium term. The index is not expected therefore to track income or expenditure closely. Whereas the communal assets may be slower to react to improvements in economic circumstances, due to the slow response of public social provision itself, the private assets may more readily adjust as households improve their ability to afford private assets. Our analysis of the data thus cautions against using asset indices to read into it short or medium term economic mobility or variability in social welfare.

In the current literature, principal components or factor analysis (PCA) is most widely used for the construction of asset indices. However, PCA was essentially designed for continuous variables as it assumes a normal distribution of indicator variables. In contrast, multiple correspondence analysis (MCA) makes fewer assumptions about the underlying distributions of indicator variables and is more suited to discrete or categorical variables. Hence, we opted in this paper to employ MCA rather than PCA in constructing the asset index employed in our analysis of poverty.³ More detail on the two methods is included in Appendix C to this paper.

² Booysen (2002), for example, employs data from 19 variables in his application of the asset index approach to the measurement of poverty to the South African DHS, while the Health, Nutrition and Population (HNP) country reports employ data from 15 variables (World Bank, 2000). Sahn and Stifel (2000), however, employ eight variables only in their analysis of poverty in nine African countries. In all three cases, the asset indices were derived from the survey data with the aid of principal component analysis (PCA).

³ We applied PCA to the same set of variables employed in our MCA analysis to construct an asset index similar to that employed by Filmer and Pritchett (1998), using the *factor* command in Stata8 (Statacorp,

The following equation was used to calculate a composite asset index score for each population unit (or household):

$${}^{MCA}P_i = R_{i1}W_1 + R_{i2}W_2 + \dots + R_{ij}W_j + \dots + R_{iJ}W_J$$

Where ${}^{MCA}P_i$ is the i^{th} household's composite poverty indicator score, R_{ij} is the response of household i to category j , and W_j is the MCA weight for dimension one applied to category j . MCA was employed to calculate these weights, using the *mca* command in Stata8 (Statacorp, 2003; Van Kerm, 1998). This command estimates "an adjusted simple correspondence analysis on the Burt matrix constructed with" the selected variables, in our case those noted in Table 1. Given that "a simple correspondence analysis applied to this matrix usually results in maps of apparently poor quality... *mca* [as employed in this paper] adjusts the obtained principal inertias (eigenvalues) following a method suggested by Benzecri and presented in Greenacre (1984)" (Van Kerm, 1998: 214). According to Van Kerm (1998: 214), the reported inertia explained by the first dimension is relatively high "due to the fitting of [these] diagonal sub-matrices". In our case, the first dimension explained 94.4% of inertia compared to the 41.4% explained by the first dimension when no such adjustment is allowed.⁴

In using the asset indices to consider the evolution of poverty over time, it is also necessary to construct asset indices that are comparable over time. There are two possibilities that would enable comparison over time. One the one hand, the asset index can be constructed using 'pooled' weights obtained from the application of MCA to all available data, in our case the data for all seven countries for all three periods. On the other hand, the index can

2003). The asset index were calculated as follows: ${}^{PCA}P_i = \{(R_{i1} - A_1)/S_1\}W_1 + \{(R_{i2} - A_2)/S_2\}W_2 + \dots + \{(R_{ij} - A_j)/S_j\}W_j$, where ${}^{PCA}P_i$ represents the i^{th} household's composite poverty indicator score arising from PCA, R_{ij} is the response of population unit i to category j , W_j is the PCA weight applied to category j , and A_j and S_j are the mean and standard deviation of the responses to category j . The first factor explained 27.5% of variance in the underlying construct 'household welfare'. In terms of the weighting of index components, the two methods give similar results in most respects, although we also found some discrepancies. In the case of the MCA analysis, for example, 'smart floor' as expected ranks higher than 'cement floor', whereas the relationship between the weights for these two variable categories is reversed in the case of the results of the PCA analysis. This anomaly may be the results of PCA having less discriminatory power than MCA, given the exclusion from the analysis of 'other' types of floor material. This also suggests, as argued above, that MCA is more appropriate for such analysis as it results in more consistent rankings across index components. This asset index was highly and statistically significantly correlated with the index based on MCA ($r = 0.953$, $p < 0.01$). Furthermore, a comparison of the welfare ranking of households based on the PCA and MCA indices reveals that the same households are not necessarily placed in the same quintile on the two indices, although deviations for the most part are restricted to one quintile up or down. This has implications for the expected results of using the two indices to measure poverty at a certain 'poverty line'. If for example the poverty line is chosen to be lower than the upper limit of the second quintile, the PCA and MCA asset indices here will give different answers in terms of the estimated level of poverty. However, our results suggests that this effect is negligible if the bottom 40% of the population is used as a measure of poverty, as is done in this report, or even if the bottom 60% of the population is classified as poor.

⁴ Despite the huge difference in the reported proportion of inertia or variance explained by the first principal component (PCA: 27.5%) and the first dimension (MCA: 94.4% adjusted and 41.4% unadjusted) respectively, these statistics are not directly comparable, given that MCA employs the χ^2 -distance and not the Euclidian distance in its calculation. In addition, there is less latitude on the weights from PCA, given the exclusion of the 'other' category in the three non-binary categorical variables included in the analysis. The choice, therefore, of an index being based on MCA or PCA cannot be informed by this statistic. Thus, the preference for MCA over PCA, as explained elsewhere, is based rather on the nature of the raw data and the statistical characteristics of the MCA method rather than any supposed superiority of MCA in explaining a greater proportion of variance in the underlying 'poverty' construct than PCA.

be based on ‘baseline’ weights obtained from an analysis of the data from the first period surveys for each country. On practical grounds we opted for ‘baseline’ weights, because one can apply these weights to data from subsequent surveys without having to recalculate the MCA weights and resulting asset index.⁵

In the construction of our asset index, moreover, equal weight is given to each country and to each period, i.e. the experience of one country is given the same weight as that of another, irrespective of differences in the number of households or individuals in each country. Thus, the pooled data from all seven countries cannot be interpreted meaningfully and we cannot say anything about trends in poverty in sub-Saharan Africa in general. Consequently, the emphasis in this paper is on an inter-temporal and –spatial comparison of poverty in each of the seven individual countries.

Table 1, which also reports the weights for each index component, shows that those components that reflect higher standards of living contribute positively to the asset index, while components that reflect lower standards of living contribute negatively to the asset index. The results for example show that owning an asset and having access to a flush toilet or piped water or having a smart floor increase a household’s asset index score, while not owning an asset or having no access to or access to lower quality sanitation and water supply or living in a dwelling with a lower quality floor material decreases a household’s asset index score or in other words level of welfare.

Following the construction of the asset index, we employed this index to estimate poverty measures for each country using the appropriate household survey weights.⁶ Negative index values however create problems for poverty analysis using higher orders (e.g. FGT measures for P_α where $\alpha=1$ or higher). To obtain positive asset values required for the further analysis, a value equal to the greatest negative value is added to each of the asset index values, so that the lowest observed values become zero. (Asselin (2002) and Sahn & Stifel (2003) motivate similar transformations.) A small further magnitude is also added to make the lowest value non-zero, as some poverty decomposition programmes in Stata ignore zero values. Here, the transformation entailed adding 0.1785 to the asset index.

The nature of the transformation employed in transforming these values to positive numbers of course affects the resulting poverty measures (see e.g. Sahn & Stifel, 2003), as they do not preserve the mean (simple transformations of the likes employed here will not however affect the variance). This transformation consequently implies that the values of the FGT measures other than the headcount ratio do not have any meaning on their own, but only obtain meaning in the context of the research. The absolute values of these poverty indices have been changed, but the distribution is the same as before the translation and thus the poverty measures still have meaning in a relative sense, enabling comparisons of the resulting estimates of the asset index across space or time, or also across urban and rural settings in our case (see also Sahn & Stifel, 2003). In the following paragraphs, we elaborate in more detail on our application to this data of poverty analysis.

⁵ The asset index calculated based on ‘pooled’ rather than ‘baseline’ weights were highly and statistically significantly correlated with the index based on ‘baseline’ weights ($r = 0.996$, $p < 0.01$).

⁶ In the current version of this paper we do not report confidence intervals or standard errors for the various poverty measures. These calculations require adjustments based on the respective survey design for each dataset, variables which we have only merged into the master dataset recently. The necessary confidence intervals will be reported in the final version of the paper, thus allowing us to strengthen the basis for our conclusions regarding trends in poverty in these seven African countries.

2.2 Poverty analysis

The greatest disadvantage of the FGT measures is their dependence, like that of all other poverty measures, on the poverty line.⁷ The choice of poverty line is thus crucial for poverty analysis to the extent that it can determine the conclusions of the poverty comparisons. There is no apparent non-arbitrary level at which to set the poverty line. In the case of a poverty line for money-metric poverty, poverty lines are often derived from the food consumption level required to meet caloric needs, based on prevailing consumption patterns (the food poverty line method), or from the costs of a basket of basic goods. Alternatively, international poverty lines could be used, such as the \$1 a day per capita level often used by the World Bank (2000b). For asset indices such as these, however, there is no comparable indication of what would be an appropriate poverty line.

Sahn & Stifel (2003) get round this problem in a unique, but not unproblematic, way. They derive for each country the asset index value that corresponds to World Bank estimates of money-metric poverty at the \$1 per person per day level in the same country, and then use these levels as country-specific poverty lines for their further analysis of poverty in urban and rural areas.⁸ Their asset indices use unique weights for each country (pooled across samples for the same country). Thus, no common poverty line is applied in each country and their asset poverty lines differ by country. But as comparisons across countries are not the focus of this particular study⁹, this need not concern them that much. In our case, however, where comparisons across time and countries are important, we require a common poverty line, constant across time and countries.

The Sahn and Stifel (2003) poverty lines are set at relatively high levels, where the discrimination ability of asset indices is somewhat better. We somewhat arbitrarily choose two relative poverty lines. The first captures the bottom 40% of the population (the group often mentioned as the relatively poor who deserve policy attention); the second is set at a level to capture the bottom 60% of the population, in both cases in the baseline period. Using the 40th percentile as a poverty line is quite standard and accords with what is often suggested by the World Bank for poverty analysis. Our reasons for setting the second poverty line higher, at the 60th percentile, are that asset poverty as reflected in the underlying asset variables is very high in Africa, i.e. that Africa has substantially more poverty when compared to other world regions, and that the nature of the asset index we

⁷ The Foster-Greer-Thorbecke (FGT) class of poverty measures are often employed to analyse poverty, with the basic formula of the poverty measure in its non-continuous form being $P_\alpha = \frac{1}{n} \sum_{i=1}^q \left(\frac{z - y_i}{z} \right)^\alpha$, where P_α is

the poverty measure and α can take on any non-negative value, although it is conventionally only analysed for $\alpha = 0, 1$ and 2 ; n is the number of households in the sample; q is the number in poverty; z is the poverty line; and y_i is the welfare indicator (in money-metric poverty measurement, usually income or expenditure) of the i^{th} household. An important benefit of the FGT class of poverty measures, apart from their more general form and their conformity with the most important welfare axioms, is that they are additively decomposable, i.e. the weighted values of subgroups add up to the aggregate.

⁸ There is considerable scope for doubt about the World Bank cross-country dataset. Thus, for instance, Mozambique is reported in the World Development Report 2000/2001 (their data source) to have only 37.9 per cent of its population below the \$1 per person per day poverty line, as against Nigeria's reported 70.2 per cent. Given that reported GNP per capita is one-third higher in the latter, these relative ratios between the respective headcount ratios seem unlikely.

⁹ In the case of this particular study the focus was on rural-urban inequality in Africa. A previous study, Sahn and Stifel (2000) examined changes in poverty over time in nine African countries and also attempted a comparison of trends in poverty across a number of African countries.

are using makes it a weaker instrument to discriminate at very low levels. Due moreover to the clustering of index values and rounding by programme commands, the actual weighted population in poverty in period 1 is not 40% and 60%, but 31% and 55% respectively.

An additional poverty line is estimated using the weighted sum of categories that is deemed as representing an adequate standard of living: radio, bicycle, no refrigerator, no TV, cement floor, public water and a pit latrine. Whereas the former two poverty lines represent relative poverty lines, this represents an absolute poverty line. This line is higher than the other two lines, with 76% of the weighted population falling below the poverty line. These three poverty lines are employed in the poverty analysis presented in the subsequent pages in order to illustrate how the choice of different poverty lines, including choosing an absolute rather than a relative poverty line, may affect the results of the analysis.

It is important to note that all three poverty lines employed in this paper are derived from the aggregate data, given the need for inter-spatial and –temporal comparability. These ‘common’ poverty lines bias results against rural areas. In other words, any analysis would necessarily show higher levels of poverty in rural than in urban areas, as is illustrated elsewhere. For the same reason, the rural areas’ share in overall poverty would be considerably higher than that of urban areas. This may result in incorrect poverty rankings and inappropriate policy responses to poverty alleviation. Normally, these disparities between rural and urban areas are considerably smaller and in some cases rankings are even reversed when employing poverty lines specific to different geographical areas (Duclos and Araar, 2004). Thus, these results should be interpreted with due care, in particular insofar as comparisons between urban and rural areas are concerned.¹⁰

Given the somewhat arbitrary transformation that was required to make all index values non-negative, and the rather arbitrary poverty lines adopted in this paper, it was not deemed appropriate to also calculate P_1 and P_2 . We therefore confine our poverty analysis to the poverty headcount ratio (P_0) and the investigation of stochastic poverty dominance. Stochastic dominance analysis, which is based on a comparison of the cumulative density curves or functions, and is also referred to as poverty incidence curves, is particularly important here. This is the result of the reported difficulty in making fine distinctions at the bottom end of the distribution, where asset values are bunched more closely and where there are relatively fewer unique asset values. Given that the cumulative density curves have shown no first order stochastic poverty dominance in a number of cases, one would expect little consistency in poverty rankings across P_0 , P_1 and P_2 for the same country across time.

2. Descriptive analysis of the asset index

Different combinations of the household characteristics described in Table 1 give the various different levels the asset index can assume. Table 2 reports the main descriptive statistics for the asset index, precluding the above adjustments to the index values required for our poverty analysis. In this case there are only 657 unique values that are realised. Given a sample size of between 1 493 and 12 331 households in any specific period for any country, many households will therefore have the same asset index score.

¹⁰ Due to the nature of the indicators available from these datasets, we did not deem it feasible to include some variables in a rural index and others in an urban index, as access to these assets and services, as explained elsewhere, are bias towards urban areas.

Table 2: Descriptive statistics for asset index

Statistic	Value
Mean	0.017
Standard deviation	0.253
Mode	-0.147
Minimum	-0.178
Maximum	1.053
Unique values	657

A crude measure of the discriminating power of the asset index is the number of unique values that the asset index assumes in each of the quintiles, as shown in Table 3. The discrimination ability of the index is lowest at the bottom end of the scale (which is also evident from scatter plots of the data).

Table 3: Number of unique index values by quintile

Quintile of asset index	Unique values
Quintile 1	6
Quintile 2	18
Quintile 3	78
Quintile 4	128
Quintile 5	463
<i>Total</i>	<i>693</i>

Given this problem with the ability of the asset index to discriminate between households, particularly at the lower end of the distribution, it is necessary to determine how these unique values are composed in terms of scores on specific index components. As shown in Table 4 access to public services is more important at the lower end of the asset index, while private asset ownership matters more at the upper end of the distribution.

Table 4: Composition of some unique asset index values

Closest to:	Index Value	Freq.	Presence of...				Type of...		
			Radio	TV	Fridge	Bicycle	Toilet	Flooring	Water
Lowest value	-0.1784	9 044	no	no	no	no	none	earth	well
Mode	-0.1469	9 159	no	no	no	no	pit latrine	earth	well
25 th percentile	-0.1460	7 401	no	no	no	no	pit latrine	earth	surface
Median	-0.0674	5 571	yes	no	no	yes	pit latrine	earth	well
Mean	0.0179	3 033	yes	no	no	no	pit latrine	cement	well
75 th percentile	0.0399	2 861	yes	no	no	no	pit latrine	cement	public tap
Highest value	1.0526	1 107	yes	yes	yes	yes	flush	smart	piped

Notes: The unique values of the asset index shown are those where the frequency of the index value was greater than 500 closest to the value of the descriptive statistic in the left most column. This was to avoid reporting anomalous index values (corresponding to only a few households)

As access to water or sanitation is to a large degree not a reflection of the money-metric poverty or lack thereof of a community, but of their geography. Although access to these

services is certainly an important dimension of experienced deprivation, measuring differences in household welfare in terms of differences in access to public services alone (as happens to be the case at the bottom end of the asset index) conceals important differences in poverty within a community. The limited discrimination ability at the lower end of the scale makes the asset index a poor tool for distinguishing between segments of the population who may be almost equally poorly served by public services.¹¹ This holds important implications for the poverty indicators and conclusions that one draws from these analyses, particularly if the poverty line is set relatively low (refer discussion elsewhere). Hence, this asset index is perhaps best employed as a crude indicator of the relative social welfare ranking of the population within relatively broad categories.

Figure 1: Assessing the robustness of poverty comparisons

		Classification of household on welfare measure B	
		Non-poor	Poor
Classification of household on welfare measure A	Non-poor	A	B
	Poor	C	D

We also assessed the robustness of the asset index as a poverty measure. This analysis however was not applied to any of the countries included in the analysis reported elsewhere in this paper. Instead the analysis was applied to the 1995 DHS data for Uganda.¹² The reason for choosing this particular survey is the inclusion in the survey of a question on the

¹¹ Interestingly, the addition of more variables to the asset index need not enhance its discriminating ability and therefore its validity as an alternative measure of household welfare. This is evident from a comparison of the results presented in Tables 2 to 4 and similar results from descriptive analysis of the asset index constructed for Uganda based on a set of 15 variables from the 1995 DHS survey (refer discussion page 12). In this case, the asset index included fewer unique variables (437). The 2nd (1), 3rd (1) and 4th quintiles (12) of the asset index also included much fewer unique variables compared to the asset index employed here, this despite the index including almost twice as many variables. In addition, we also found that access to public services is more important at the lower end, while private asset ownership matters more at the upper end of the distribution of the index for Uganda, as was the case with the asset index employed in this paper. Thus, the mere addition to the analysis of more variables and importantly in this case of relatively similar variables need not improve the ability of the resulting composite index to discriminate between households at different levels of welfare. What may be required rather is the addition of variables that reflect other distinct dimensions of household welfare, such as access to health care services and employment. Care should be taken however in doing so insofar as the addition to the index of continuous variables, such as number of rooms for sleeping and years of education, would mean that the use of MCA in constructing the asset index is not defensible. (The published literature has seen the indiscriminate application of PCA to both continuous and categorical variables in deriving asset indices.) This represents an important avenue for methodological innovation, given that datasets include both categorical and continuous variables, all of which can be employed simultaneously in the construction of a composite measure of multi-dimensional poverty.

¹² Actually, similar data is available for Senegal. We only realised this following a recent detailed comparison of DHS datasets for the selected seven countries. This review followed in response to issues raised by one of the reviewers on the previous draft of this paper. Thus, we will replace the results presented here with similar results calculated using the 1996 DHS data for Senegal. This means that this particular discussion will then fit better into the framework of the larger paper. For now however the Ugandan results are employed to illustrate the relative inconsistency of the poverty rankings based on the asset index and those based on alternative poverty measures.

adequacy of consumption. This allows a comparison between the asset index and an indicator associated more closely with a money-metric measure of household welfare, in this case household consumption.¹³ Firstly, we constructed an asset index with the aid of the methodology describe above, based on an analysis of a total of 13 variables from this dataset. Apart from the variables included in the asset index specified elsewhere, we also included binary variables on five other household level assets, viz. the presence or absence of a motorcycle, car, telephone, video recorder and cooker, as well as a variable indicating whether the household has access to electricity or not. We then proceeded to compare the resulting classification of households as poor or non-poor (based on the 40th and 60th percentiles of the asset index) with four likewise albeit arbitrary classifications of households based on three alternative measures of household welfare. A poverty measure we argue can be considered relatively more robust the larger the proportion of households classified as poor on either measure (areas B, C and D in Figure 1) that is classified as such on both measures (area D in Figure 1). Households were classified as poor (non-poor) where...

- HHCONS1: Household consumption was described as ‘always in deficit’ (‘occasionally in deficit’, ‘not in surplus or deficit’ or ‘in surplus’).
- HHCONS2: Household consumption was described as ‘always’ or ‘occasionally’ in deficit (‘not in surplus or deficit’ or ‘in surplus’).
- EDUC1: The household head had no education or a primary education only (secondary or tertiary education).
- EDUC2: The total years of education of all household members were less than 13 years (in excess of 12 years).¹⁴

Table 5 reports on the pair-wise classifications of household as poor or non-poor based on the four sets of alternative poverty measures described above. Evident from the results is that there is not a great degree of overlap between the classifications on the asset index and those based on alternative measures of household welfare. In fact, when employing the 40th percentile of the asset index as the guideline, sixty-four percent or more of households classified as poor on either measure is classified as poor on one measure only. In other words, thirty-six percent or less of households classified as poor on either measure is classified as poor on both measures. The classifications based on the 60th percentile of the asset index are overlap slightly more. Yet, forty percent or more (sixty percent or less) of households classified as poor on either measure is classified poor on one measure only (both measures).

¹³ A comparison based on the asset index and a classification based on a money-metric poverty measure such as income or expenditure would have been ideal, but none of the DHS surveys collected such data. Obviously, a categorical variable of this nature can also be included in the MCA analysis employed in constructing the asset index. However, this would preclude the use of such variable as an alternative measure of household welfare with which to assess the robustness of the asset index as a measure of poverty.

¹⁴ Secondary education, we arbitrarily assume, greatly enhances the probability of a household head finding employment and the household therefore being non-poor. Twelve years of education, which is equivalent in most countries to a full secondary education, we equally arbitrarily assume enhances the probability of one or more household members finding employment and therefore being non-poor. Of course, a household headed by a person with a university degree and a good job can still be classified as poor where this income is distributed across a relatively large number of household members. In addition, total years of education are distributed unequally across all household members, which mean that the specified cut-off employed in our analysis need not guarantee a household an escape from poverty. We fully realise and recognise these limitations of the above classifications, yet include these results here as an illustration of the relatively poor discriminating ability of the asset index when compared to alternative measures of poverty.

Table 5: Pair-wise comparisons of the classification of Ugandan households on alternative poverty measures (1995)

Asset index		Alternative measures of poverty							
		HHCONS1		HHCONS2		EDUC1		EDUC2	
		Non-poor	Poor	Non-poor	Poor	Non-poor	Poor	Non-poor	Poor
Asset index (40 th percentile)	Non-poor	3,998	1,334	1,798	3,534	1,574	3,604	2,629	2,716
	Poor	1,140	1,005	406	1,739	117	2,007	382	1,767
Asset index (60 th percentile)	Non-poor	2,993	704	1,460	2,237	1,387	2,176	2,139	1,566
	Poor	2,145	1,635	744	3,036	304	3,435	872	2,917

Note: According to Chi2 tests, the proportion of households classified as poor differ statistically significantly between these poverty measures in all cases ($p < 0.01$).

This relatively low degree of overlap in the poverty rankings highlights the fact that any multidimensional measure of poverty, such as the asset index employed here, as argued elsewhere, represents but an alternative poverty measure. The relative completeness of any such measure depends crucially on the number and diversity of the indicators included in the analysis, which is largely driven by data availability. The results of any analysis based on such measure, as explained elsewhere needs to be interpreted within the context of the conceptual and methodological limitations of the particular measure of welfare.

3. Poverty analysis

In this section, we first elaborate on trends in the incidence of poverty within countries, as well as differences between these seven African countries in the magnitude of poverty. Following this, we perform stochastic dominance testing using cumulative density functions. An urban-rural decomposition of poverty precedes a decomposition of inter-temporal changes in poverty into individual index components. The latter is required to tie the observed trends and disparities in poverty to changes in access to public services and private asset ownership, thus hinting at possible policy implications of the analysis, especially as far as access to public services are concerned.

3.1 Inter-temporal and –spatial differences in the incidence of poverty

Table 6 reports poverty headcount ratios for the seven countries in each of the three periods as well as on average, based on the pooled data for each country. Results are reported separately for each of the three poverty lines: the 40th and 60th percentiles of the asset index (the two relative poverty lines) and the absolute poverty line (refer discussion above). We first focus on the trends in poverty in each country (inter-temporal comparisons), following which our focus shifts to a comparison of the seven countries (inter-spatial comparisons).

The results show that poverty has declined over this period in five of the seven countries: Ghana, Kenya, Mali, Senegal and Zimbabwe, regardless of the choice of poverty line. For Tanzania, different results were reported for the relative and absolute poverty lines. Table 6 reports a decline in the poverty headcount in Tanzania when using a 40th or 60th percentile poverty line, but when using an absolute poverty line, it shows an increase in poverty. This illustrates how the choice of a different poverty line may translate into completely different

results as to the reported trend in poverty over time. In the case of Zambia, poverty has increased between Period 1 and 3, regardless of the choice of poverty line employed in the analysis.

The sensitivity of poverty comparisons to the choice of poverty line is aptly illustrated in a comparison of the seven countries during each individual time period. Not in one period, are the countries ranked in the same order on each of the three poverty measures. In certain instances, the use of the absolute poverty line has seen a complete shift in the relative ranking of the different countries. Rankings in some instances also shifted considerably across the two relative poverty lines. However, a number of consistencies do emerge from these relative rankings. Tanzania in each period ranked amongst the bottom two countries, whereas Senegal and Zimbabwe ranked amongst the top three countries in each period. Kenya in turn consistently ranked in the middle, ranked 3rd or 4th in each period. However, poverty analysis based on the headcount index alone might be an oversimplification, given its illustrated sensitivity to the choice of poverty line. For this reason, we next consider the cumulative density curves for each these seven countries.

Table 6: Poverty headcount ratios (%)

Country	Period	40 th Percentile poverty line	60 th Percentile poverty line	Absolute poverty line
Ghana	Period 1	21.6	37.5	83.2
	Period 2	10.6	26.6	72.5
	Period 3	8.8	21.5	64.6
	<i>All periods</i>	<i>12.2</i>	<i>26.9</i>	<i>71.7</i>
Kenya	Period 1	29.5	59.6	79.9
	Period 2	34.0	59.9	78.8
	Period 3	26.3	54.8	71.4
	<i>All periods</i>	<i>29.9</i>	<i>57.8</i>	<i>76.2</i>
Mali	Period 1	47.0	80.0	95.6
	Period 2	38.0	75.0	88.8
	Period 3	24.7	66.7	80.9
	<i>All periods</i>	<i>31.9</i>	<i>71.2</i>	<i>85.3</i>
Senegal	Period 1	16.3	47.1	75.8
	Period 2	17.2	41.5	59.5
	Period 3	18.2	40.4	57.3
	<i>All periods</i>	<i>17.6</i>	<i>41.8</i>	<i>60.9</i>
Tanzania	Period 1	49.1	72.4	88.4
	Period 2	41.3	69.9	88.9
	Period 3	41.0	68.6	92.1
	<i>All periods</i>	<i>44.5</i>	<i>70.7</i>	<i>89.3</i>
Zambia	Period 1	39.4	52.6	69.6
	Period 2	41.8	60.3	74.3
	Period 3	43.4	60.8	75.2
	<i>All periods</i>	<i>41.6</i>	<i>58.2</i>	<i>73.2</i>
Zimbabwe	Period 1	27.7	41.9	63.5
	Period 2	28.8	43.7	63.7
	Period 3	18.7	31.7	57.0
	<i>All periods</i>	<i>24.4</i>	<i>38.4</i>	<i>60.8</i>

A comparison of the general trends in poverty observed here and trends reported in other sources for roughly equivalent periods reveals that although most trends are confirmed, a few are not. (Obviously, the use of different poverty measures and poverty lines and the

absence of reported confidence intervals for these poverty estimates preclude a precise comparison. The emphasis, therefore, is on general trends alone.) Poverty in Ghana is reported to have declined from 50% to 39.5% between 1992 and 1998 (World Bank, 2005). Teal (2001) also report that poverty has declined in Ghana, but over a longer period (1988-98), dropping from 53% to 45%. Likewise, poverty in Tanzania declined from 38.6% to 35.7% between 1991 and 2000. In Zambia, however, the percentage of the population living under the poverty line increased from 69.2% to 72.9% between 1996 and 1998. In Zimbabwe's case, the incidence of poverty also increased between 1990 and 1995, rising from 25.8% to 34.9% (World Bank, 2005). Our results also show that poverty declined in Ghana (Periods 1 to 2 and 1 to 3: all poverty lines) and in Tanzania (Periods 1 to 3: relative poverty lines only), while poverty increased in Zambia (Period 2 to 3: all poverty lines) and Zimbabwe (Periods 1 to 2: all poverty lines). In Kenya's case, however, we find that poverty declined between Periods 2 and 3, whereas poverty estimates derived from other data sources suggest that poverty has been on the rise in the 1990s (Republic of Kenya, 2004; World Bank, 2005). Yet, Chen and Ravallion (2004), using a \$1 a day poverty line to calculate poverty headcounts for different regions, report that poverty in Sub-Saharan Africa has declined between 1987 and 1999. The proportion of the population living below the poverty line has decreased from 46.8 to 45.7 over this period, a general trend confirmed in five out of the seven countries included in our analysis. However, Chen and Ravallion (2004) report that between 1999 and 2001 poverty returned again to 1987 levels. As few of the datasets included in our analysis postdates 1998, we are not in a position to present evidence that may confirm this general increase in poverty in sub-Saharan Africa in more recent times.

3.2 Cumulative density curves

In most cases it is not possible to reach strong conclusions on poverty trends in each of these seven countries based on the cumulative density curves in Figures 2a to 2g. The case of Tanzania is perhaps the clearest case in point. The cumulative density function for period 3 does not always lie below that for period 1 (Figure 2e), giving rise to uncertainty as to whether there has been progress in terms of the incidence of poverty, at least based on these results. In places the three curves are almost indistinguishable. Thus, visual inspection of the cumulative density function does not provide clear answers. However, if we focus only on the poverty relevant range, say where the poverty headcount ratios are somewhere between 20% and 60%, there is stochastic dominance in more cases. In other words, at these ranges the incidence of poverty did decline (or increase) across the distribution. However, as long as the curves cross at lower levels of the asset index, this allows no unequivocal conclusion on second and third order poverty dominance.

Figure 2a:

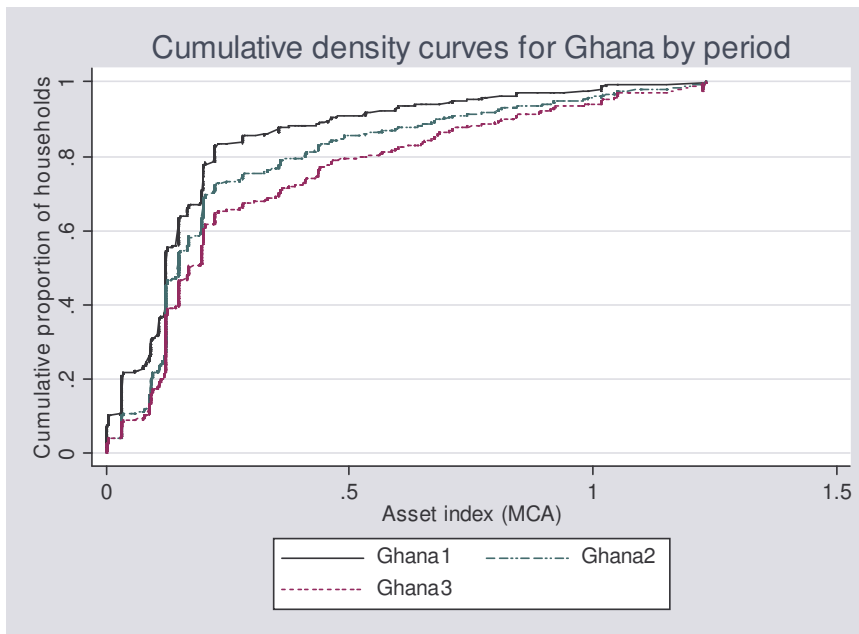

Figure 2b:

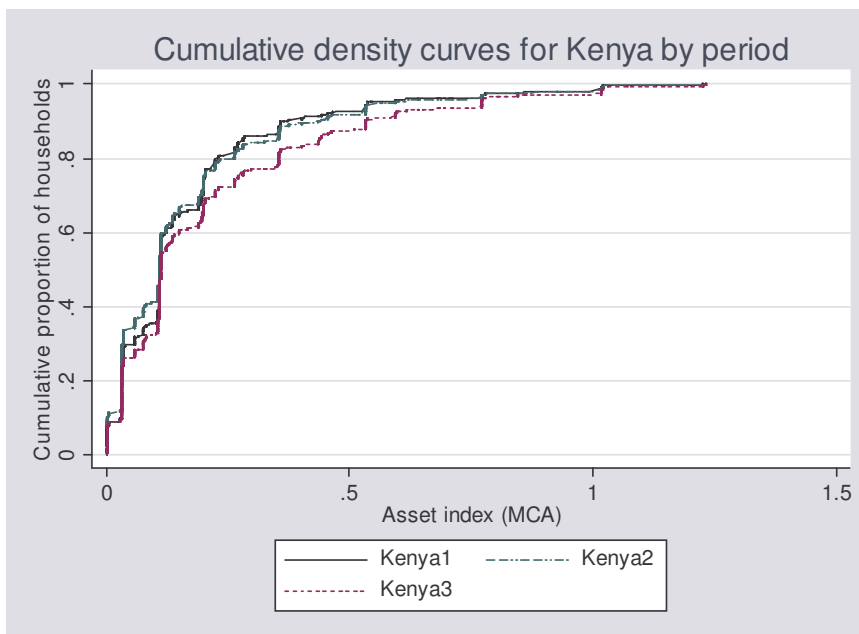

Figure 2c:

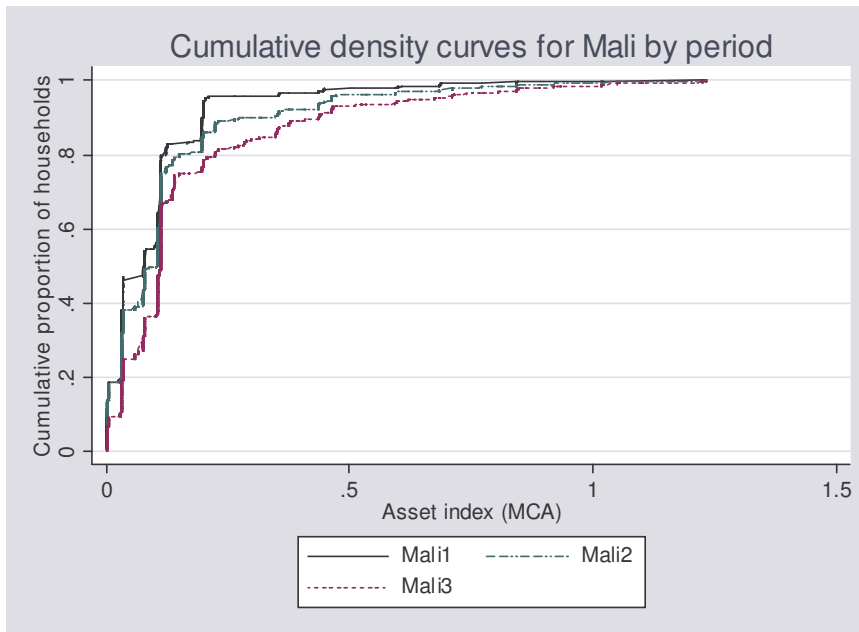

Figure 2d:

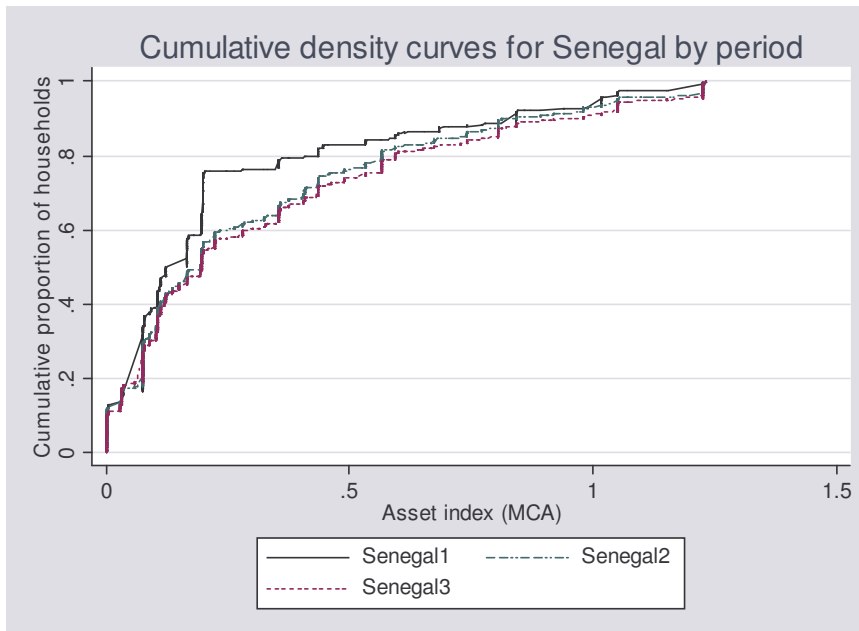

Figure 2e:

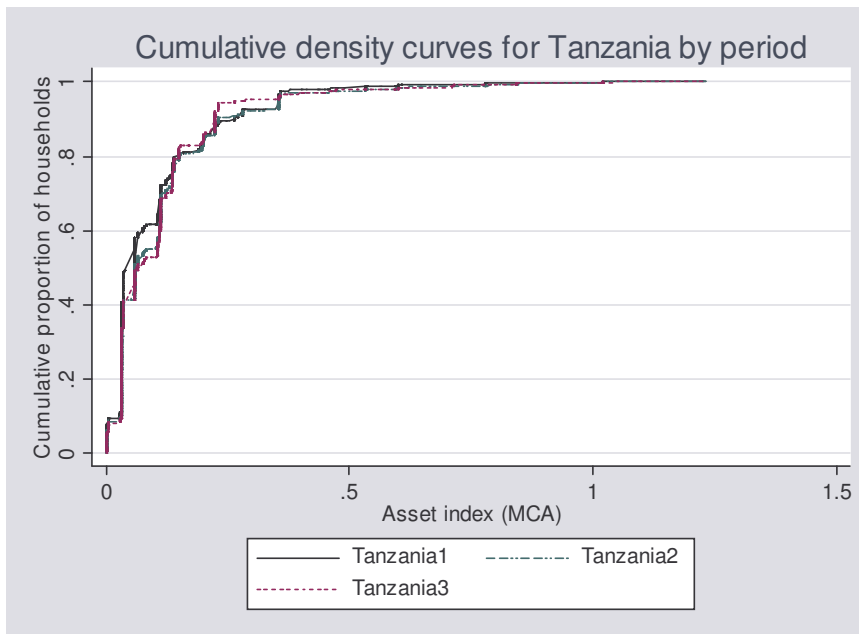

Figure 2f:

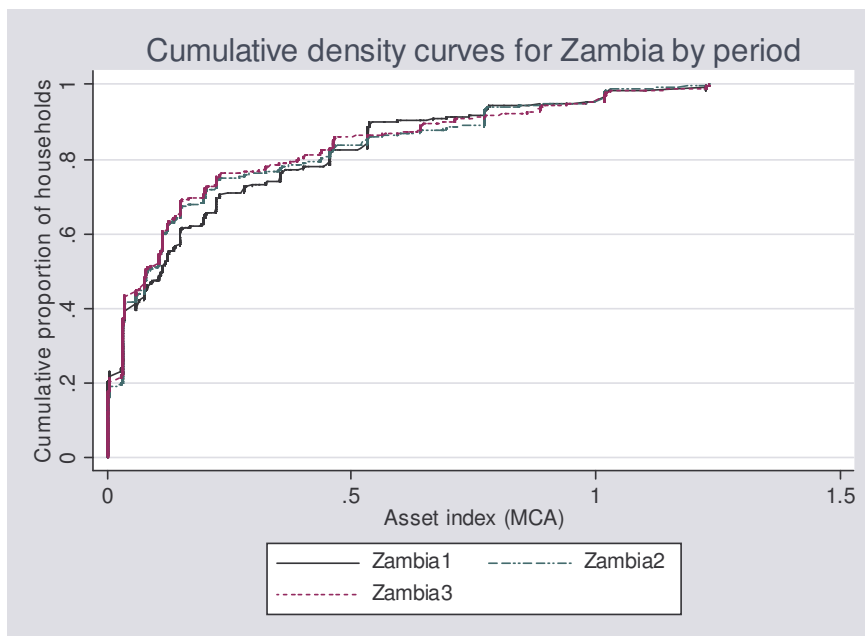
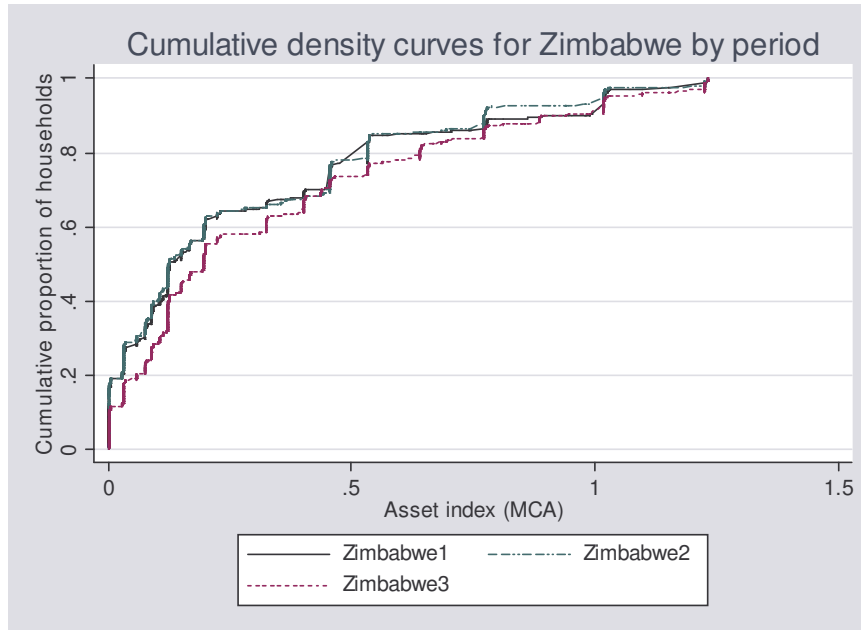

Figure 2g:



Figures 3a to 3c in turn show cumulative density curves for all seven countries in each of the periods. It appears that poverty is most prevalent in Tanzania, Mali and Zambia, with particularly Mali seeming to have experienced some considerable change in the pattern of asset welfare amongst the poorer segments of its population, as the cumulative distribution curves for that country across the different periods show. According to the asset index Ghana has the least poverty and is followed by Kenya and Zimbabwe. Yet, first order stochastic poverty dominance is relatively uncommon, i.e. many of the lines cross in places. Thus, as illustrated in Table 6, poverty rankings are relatively sensitive to the choice of poverty line. In the case of Ghana and Mali however the curves meet, but do not cross. In these two cases it is thus possible to say that poverty has clearly not become worse, whichever poverty line is used for the analysis.

Figure 3a:

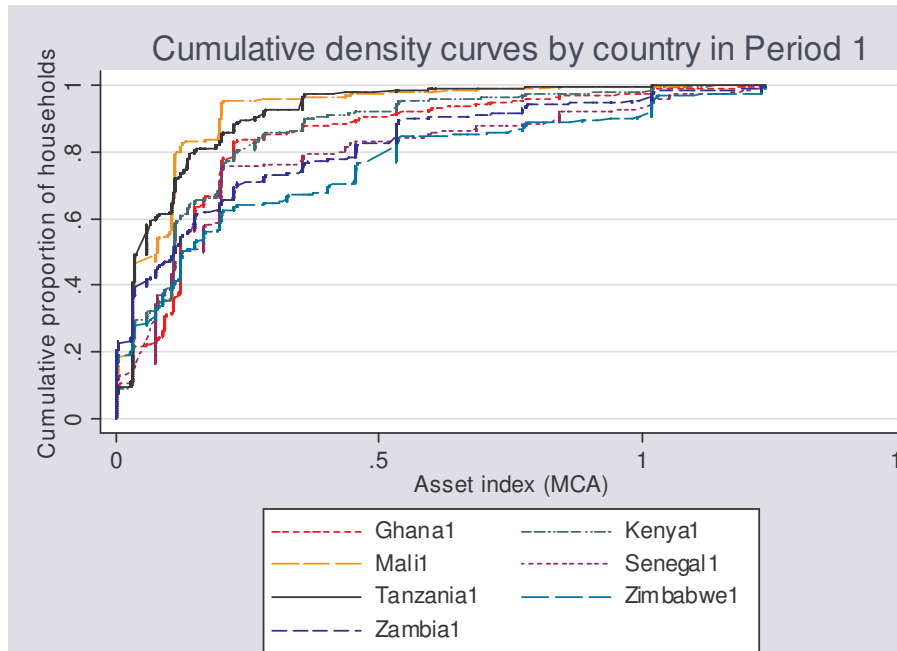

Figure 3b:

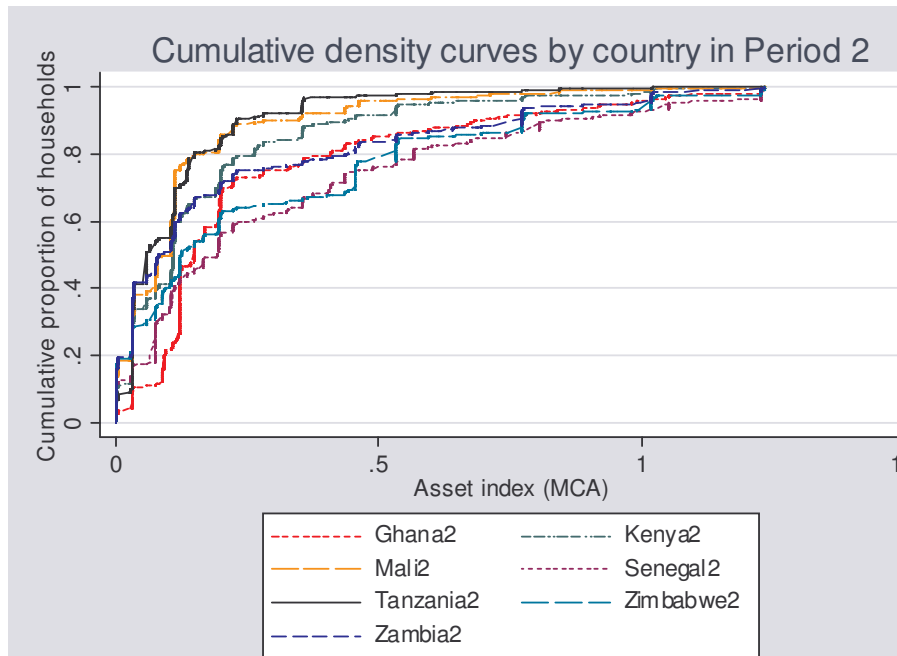
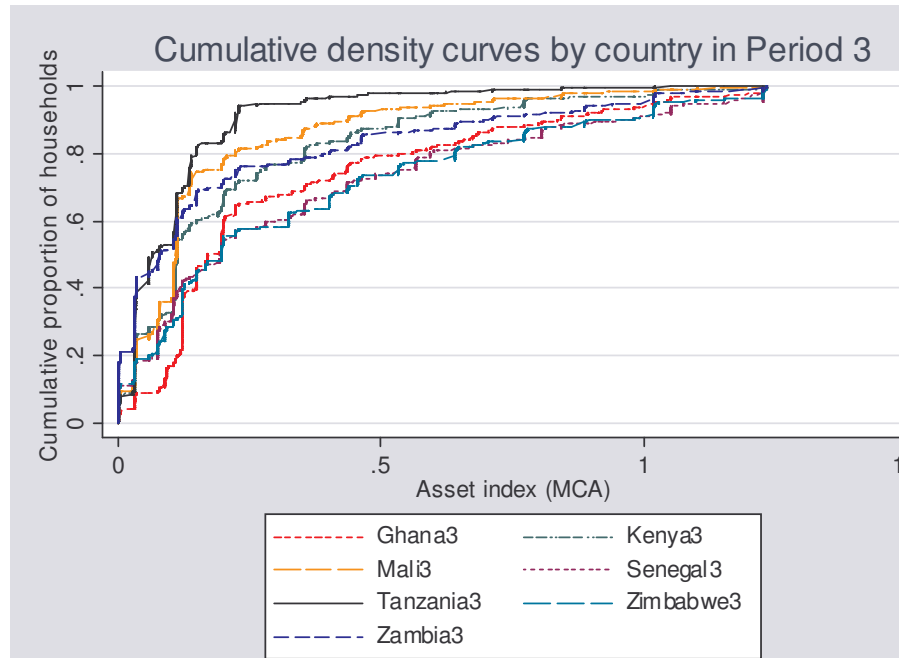

Figure 3c:



3.3 Urban-rural decomposition of poverty estimates

Our analysis at this stage has said nothing about causality (or factors that explain differences in the incidence of poverty). The data at our disposal moreover does not allow such an analysis. However, one dimension of intra-country differences in welfare, which can be analysed further with the aid of the current dataset, is location. This can throw some light on the part that urban and rural settings play in understanding differences in poverty estimates. Table 7, which reports the poverty headcount ratios, shows that urban poverty measured by these assets is minimal, whereas rural poverty is very common. Estimates of urban and rural poverty for these countries reported in the *World Development Indicators* likewise in all cases show rural poverty to exceed urban poverty (World Bank, 2005). This, as explained elsewhere, is the result of employing a common rather than regional poverty line in the analysis.

In addition, it may be argued that the assets included in the asset index are by their nature urban rather than rural and therefore are conceptually biased against rural areas. Indeed, in most of Africa, governments regard the provision of formal housing, water and sanitation services as naturally urban services. Yet as countries develop, it would not be amiss for the rural population to strive towards having piped water, flush toilets and “smart” floors. Additionally, private assets such as radios, TVs and fridges play an important role in moving people out of asset poverty, particularly at the higher poverty line. Access to these assets may be a better reflection of people’s performance in the market and thus also their ability to maintain a higher standard of living. Hence, the estimates of urban and rural poverty reported here should be interpreted with due care.

Table 7: Incidence of poverty in urban and areas (%)

	Poverty line set at 40 th percentile				Poverty line set at 60 th percentile			
	Period 1	Period 2	Period 3	All periods	Period 1	Period 2	Period 3	All periods
A. Incidence of poverty in urban areas (%)								
Ghana	3.2	0.5	0.3	1.0	10.1	6.4	3.8	10.1
Kenya	4.1	3.2	3.2	3.4	13.1	10.7	10.1	11.4
Mali	12.7	12.0	6.4	9.2	30.2	29.6	21.9	28.7
Senegal	0.9	3.0	2.4	2.4	5.5	8.1	6.2	7.8
Tanzania	13.1	9.0	7.2	10.4	30.5	23.4	21.4	27.2
Zambia	4.2	6.2	7.2	5.8	12.1	13.3	13.8	15.0
Zimbabwe	0.7	0.6	0.1	0.4	1.1	0.8	0.4	1.1
B. Incidence of poverty in rural areas (%)								
Ghana	30.4	16.2	13.4	18.2	50.6	37.8	31.2	48.5
Kenya	35.2	41.3	33.5	36.8	70.1	71.5	68.7	70.6
Mali	58.0	47.9	30.7	39.8	96.1	92.3	81.4	87.3
Senegal	26.1	27.5	29.6	28.3	73.5	65.9	64.8	68.3
Tanzania	60.7	50.6	53.0	55.2	85.9	83.3	85.3	85.1
Zambia	67.9	62.8	62.2	63.9	85.4	87.9	85.3	87.5
Zimbabwe	40.7	42.2	30.0	37.1	61.6	63.9	51.0	68.0

The trends in urban and rural poverty reported in Table 7 mirror the general trends in poverty reported in Table 6 for the two relative poverty lines. The results show that poverty has declined in urban and rural areas in five of the seven countries: Ghana, Kenya, Mali, Tanzania and Zimbabwe. In Zambia, however, urban poverty has increased, while poverty in rural areas has declined. For Senegal, moreover, different results were reported for the two relative poverty lines. Table 7 reports a decline in the urban poverty headcount in Senegal when using a 60th percentile poverty line, but when using a 40th percentile poverty line, it shows an increase in poverty over this period.

Again, however, our comparison of general trends in urban and rural poverty reported here and those reported in other sources for roughly equivalent periods reveals that, although some trends are confirmed, others are not. (Obviously, the use of different poverty measures and poverty lines precludes a precise comparison. The emphasis, therefore, is on the general trends alone.) Rural poverty in Tanzania is reported to have declined from 40.8% to 38.7% between 1991 and 2000. In Zimbabwe's case, the incidence of poverty in rural areas also increased between 1990 and 1995, rising from 35.8% to 48% (World Bank, 2005). Our results also show that rural poverty declined in Tanzania over this period, while rural poverty increased in Zimbabwe between Periods 1 and 2. In Kenya's case, however, we find that poverty declined between Periods 2 and 3 in urban and rural areas, whereas poverty estimates derived from other data sources suggest that poverty has been on the rise in the 1990s in particular in urban but also in rural areas (Republic of Kenya, 2004; World Bank, 2005).

Table 8: Mean access to assets by location, all countries and periods pooled

Indicator		Urban	Rural	Total
Average household size		5.29	5.63	5.52
Private assets	Radio	68.4%	43.2%	50.8%
	TV	31.4%	3.2%	11.7%
	Fridge	19.4%	1.0%	6.6%
	Bicycle	17.6%	29.1%	25.6%
Sanitation	Flush toilet	34.9%	1.5%	11.5%
	Pit latrine	58.1%	65.7%	63.4%
	Other toilet	2.4%	0.7%	1.2%
	No toilet	4.6%	32.1%	23.8%
Floor of dwelling	Smart floor	13.8%	1.4%	5.1%
	Cement floor	66.5%	22.7%	35.9%
	Earth floor	18.6%	75.3%	58.3%
	Other floor	1.2%	0.6%	0.8%
Water	Piped water	43.4%	4.0%	15.9%
	Public water	35.3%	11.4%	18.6%
	Water from well	15.8%	52.4%	41.4%
	Surface water	3.9%	30.7%	22.7%
	Other water	1.6%	1.4%	1.5%

To determine what drives the differences between urban and rural welfare as measured by the asset index, Table 8 shows mean asset ownership and access broken down by urban versus rural location based on the pooled dataset. The main differences in water provision lie in urban areas having more access to piped water in the home or public water (standpipes). In sanitation, the most evident difference is in the greater prominence of flush toilets in urban areas. In terms of the floors of dwellings, rural dwellers more commonly have earth floors versus the very prevalent cement floors in urban homes; and in private asset ownership, urban areas have an advantage in most assets, apart from bicycles, which are more common in rural areas.

Table 9 explores the explanatory power of the available location dummy. It depicts a number of OLS regressions of the asset index, regressed on location (urban-rural), country, and time (period), and in some cases also interaction variables between country dummies and the dummy for urban. Particularly noticeable in these regressions are:

- The importance of urban location for asset wealth. In Equation 1, a full 36% of the variation in asset wealth can be explained by the spatial factor alone.
- The poor performance of Tanzania, the reference country; compared to Tanzania, all other countries show positive and statistically highly significant coefficients, indicating better performance than Tanzania, in all the equations in which the country dummies enter. This is so despite the fact that Equation 2 gives a very low R-squared, indicating that country differences explain only a small part (7%) of the variation in asset welfare.
- The good performance of Zimbabwe and Senegal, with both of them also showing a particularly strong performance in urban areas, as Equation 5 shows.
- By far the largest part of what can be explained by these variables (around 40%) can be ascribed to the explanatory role of location. Variation between countries is a much smaller factor than variation between urban and rural areas.
- Over time, there is clear improvement in the asset index.

- All these relationships are statistically significant, including the interaction variables between urban location and the country dummies. Compared to Tanzania, all other countries also show an even stronger performance in urban than in rural areas.

Table 9: OLS regressions of asset index

	Equation 1	Equation 2	Equation 3	Equation 4	Equation 5
Urban	0.344 (266.56)**		0.334 (264.68)**	0.334 (265.53)**	0.158 (48.51)**
Ghana		0.159 (58.15)**	0.122 (55.59)**	0.113 (51.01)**	0.088 (34.63)**
Kenya		0.079 (31.92)**	0.090 (45.08)**	0.081 (40.53)**	0.052 (23.91)**
Mali		0.039 (15.83)**	0.033 (16.64)**	0.018 (8.93)**	0.016 (7.18)**
Senegal		0.211 (67.54)**	0.152 (60.61)**	0.140 (54.92)**	0.068 (22.31)**
Zambia		0.109 (43.40)**	0.061 (29.96)**	0.054 (26.72)**	-0.002 (0.65)
Zimbabwe		0.200 (73.59)**	0.164 (75.14)**	0.154 (69.86)**	0.049 (19.29)**
Period 2				0.014 (9.58)**	
Period 3				0.044 (28.30)**	
Urban*Ghana					0.154 (32.89)**
Urban*Kenya					0.155 (33.47)**
Urban*Mali					0.078 (17.90)**
Urban*Senegal					0.279 (53.97)**
Urban*Zambia					0.229 (53.21)**
Urban*Zimbabwe					0.388 (83.39)**
Constant	0.103 (145.37)**	0.108 (60.13)**	0.028 (19.09)**	0.014 (8.58)**	0.070 (44.10)**
<i>Observations</i>	<i>125 841</i>	<i>125 841</i>	<i>125 841</i>	<i>125 841</i>	<i>125 841</i>
<i>R-squared</i>	<i>0.36</i>	<i>0.07</i>	<i>0.40</i>	<i>0.41</i>	<i>0.44</i>

Note: Absolute value of t statistics in parentheses. * significant at 5%; ** significant at 1%

3.4 Poverty of what?

This section considers the driving forces behind the observed shifts in the asset index. This is particularly important as this presents an avenue for tying changes in welfare to specific policies, particularly in the case of the provision of public services. Figure 6 shows that there has been much improvement in access to private assets of households in the pooled sample. In the approximate decade between Period 1 and Period 3, radio ownership expanded by 12.4 percentage points, TV ownership with 9.6 percentage points, fridge ownership increased 1.9 percentage points and bicycle ownership rose by 8.3 percentage points. Although this does not reflect rapid economic progress, it shows a broadening of ownership that must link in some way with money-metric welfare. The proportion of dwellings with cements or “smart” (carpeted, tiled, wooden) floors is an interesting

category as it can be interpreted as the outcome of a mixture of public and private provision. The category shows a marginal decline of 0.2 percentage points. In contrast, government-provided assets all exhibit a relative decline. Access to piped water and flush toilets declined: piped water in the home fell by 4.7 percentage points and access to flush toilets or pit latrines were 2.9 percentage points lower.

Figure 6:

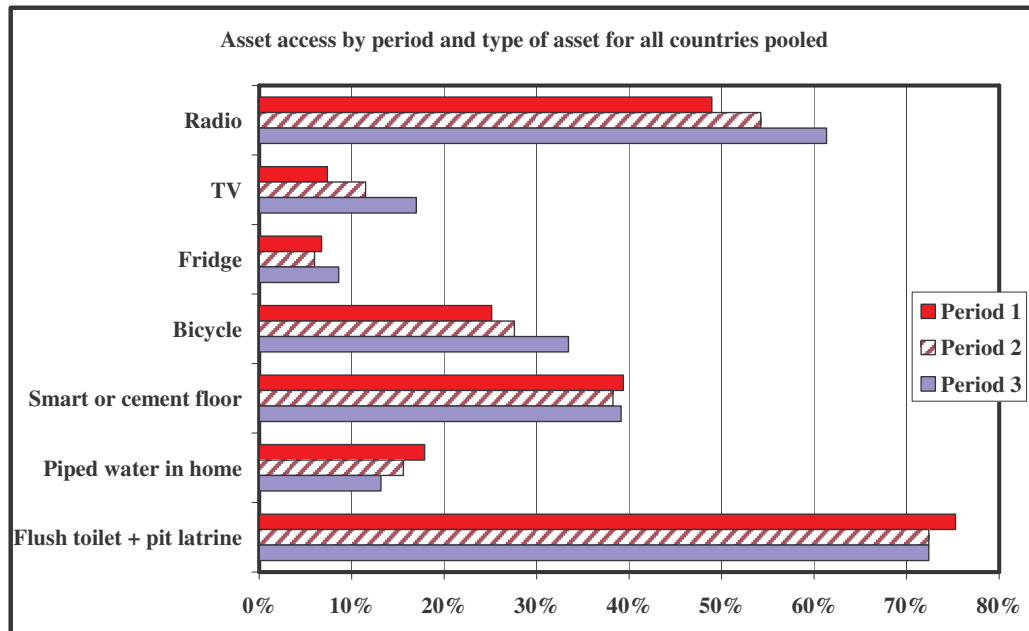

Figure 6, however, report changes over time in mean access to individual assets in the pooled dataset. Changes in the mean asset index in turn represent the net change in aggregate household welfare, which reflects the net effect of weighted changes in each indicator variable. As a result, it is possible that the mean asset index may increase (decline), this despite deteriorations (improvements) in relative access to certain assets. In addition, these aggregates may hide considerable differences between countries. For this reason, we for each country decomposed the change in the mean asset index between consecutive periods into its various positive and negative indicator components. These results are reported in Table 10. We rank the three variables that contributed most to positive and negative changes in the mean asset index. The analysis accounts for the weights of the different index components. (In cases where cells are blank, three or fewer index components actually increased or declined over the particular period.) We also note whether the mean index improved or deteriorated over this period.

The results presented in Table 10 for the most part substantiate the general trends in access to assets reported in Figure 6. In cases where the mean asset index increased between consecutive periods, access to private assets, in particular televisions and fridges, in 61.5% of cases featured amongst the top three items explaining improvements in access to assets. However, in 23.1% of cases access to public services also featured amongst the three index items explaining the largest relative increases in the mean asset index. Especially in Mali and Tanzania access to improved sanitation contributed much to the increase in the mean asset index between consecutive periods. In the remaining 15.4% of cases, improvements in floor material explained increases in the mean asset index. Yet, in many countries where

household welfare on average improved, as reflected in an increase in the mean asset index, access to assets actually deteriorated. Thus, the reported improvements in welfare would have been even greater had access to these assets not declined. Almost 70% of the top three index items that saw the mean asset index decline, concern access to water and sanitation, while the remainder are related to access to private assets. In Mali and Tanzania, declining access to improved water sources is particularly problematic, while in Zimbabwe access to both water and sanitation deteriorated in the 1990s.

Table 10: Decomposition of net changes in asset index, by index component

Country	Change between...	Net change in mean asset index	Increased access to...			Deteriorating access to...		
			1 st	2 nd	3 rd	3 rd	2 nd	1 st
Ghana	Periods 1 and 2	Up	floor material	television	fridge			
	Periods 2 and 3	Up	television	fridge	sanitation			
	Periods 1 and 3	Up	floor material	television	fridge			
Kenya	Periods 1 and 2	Down	floor material			water source	fridge	sanitation
	Periods 2 and 3	Up	television	water source	fridge			
	Periods 1 and 3	Down	television	floor material	radio	water source	fridge	sanitation
Mali	Periods 1 and 2	Up	television	sanitation	floor material	bicycle	water source	fridge
	Periods 2 and 3	Up	television	sanitation	fridge			water source
	Periods 1 and 3	Up	television	sanitation	fridge			water source
Senegal	Periods 1 and 2	Up	floor material	water source	sanitation	television	radio	fridge
	Periods 2 and 3	Down	television	bicycle		water source	sanitation	floor material
	Periods 1 and 3	Up	floor material			radio	sanitation	fridge
Tanzania	Periods 1 and 2	Up	television	fridge	radio		sanitation	water source
	Periods 2 and 3	Up	television	fridge	sanitation			water source
	Periods 1 and 3	Up	television	fridge	sanitation			water source
Zambia	Periods 1 and 2	Down	television	bicycle	radio	Floor material	water source	sanitation
	Periods 2 and 3	Down	fridge	television	material	Radio	sanitation	water source
	Periods 1 and 3	Down	television	fridge	bicycle	Floor material	sanitation	water source
Zimbabwe	Periods 1 and 2	Down	television	water source		Floor material	sanitation	fridge
	Periods 2 and 3	Up	television	fridge	floor material		sanitation	water source
	Periods 1 and 3	Up	television	material	radio	Fridge	sanitation	water source

In cases where the mean asset index deteriorated over time, declines in access to water and sanitation in the majority of cases contributed most to this decline (63.6%), particularly in Kenya and Zambia. The remainder of these declines were explained for the most part by deteriorations in access to private assets and floor material (18.2% each). Despite the decline in the mean asset index, access to some assets in many cases improved over time. This implies that the deterioration in household welfare would have been even worse had access to these assets not improved. In the majority of cases (75%), these gains in the asset index are attributable to gains in access to private assets, particularly television and

especially in Zambia. The remaining gains in the asset index are explained by improvements in floor material (18.8%) and access to improved water sources (6.3%).

Thus, despite the mean asset index reflecting progress in poverty alleviation for most countries over this period, the message is more mixed when the index is decomposed. In most cases, progress with money-metric related assets was accompanied by a decline in access to sanitation and water. When we consider this decomposition of assets, we can be far less sanguine about the progress made, for public services have been shown to be a vital component of human development. These results, therefore, hint at a particularly important role for continued efforts at the expansion of access to water and sanitation.

5. Conclusion

This paper aims to analyse trends in poverty in seven African countries towards the end of the 20th century using an asset index constructed from data from internationally standardised, comparable and nationally representative surveys. The results show that overall poverty has declined over this period in five of the seven countries: Ghana, Kenya, Mali, Senegal and Zimbabwe. In the case of Zambia, poverty has increased over this period. Poverty is most prevalent in Tanzania, Mali and Zambia, while Ghana has the least poverty and is followed by Kenya and Zimbabwe. Rural poverty in all cases exceed urban poverty, as is expected, given the use here of a common poverty line. The trends in urban and rural poverty for the most part mirror these trends in overall poverty. Poverty has declined in urban and rural areas in five of the seven countries: Ghana, Kenya, Mali, Tanzania and Zimbabwe. In Zambia, however, urban poverty has increased, while poverty in rural areas has declined.

These results, however, should be interpreted with caution, given the various conceptual and methodological limitations of the approach to poverty analysis employed in this paper. *Firstly*, the asset index does not represent a complete measure of household welfare. This limitation partly derives from the relatively small number of indicators but also the nature of the particular variables included in the index, which is driven mainly by data considerations. This problem is exemplified by the relative lack of overlap between the welfare rankings of households based on the asset index as opposed to other poverty measures.

Secondly, our analysis demonstrates the hazards of aggregation. The message here is that the policy lessons to be derived from an analysis of such composite index of economic development often only emerge from the decomposition of the index. In the case of our analysis, the aggregate index in many cases indeed reflects economic progress over time. Yet, when decomposed, these improvements in the mean asset index are largely driven by progress in the accumulation of private assets such as televisions and fridges. In contrast, access to water and sanitation has deteriorated in many cases and often explains much of the deterioration in economic progress. The only exceptions are Mali and Tanzania where improved access to sanitation contributed relatively much to the overall improvement in household welfare over time. The deterioration in access to water and sanitation is disconcerting however as these public services are essential for poverty alleviation and development. As such, continued efforts at the expansion of access to water and sanitation in sub-Saharan Africa, particularly in rural areas, are required to enhance economic development. In the *third* instance, our results aptly illustrate the problems evident in

comparing poverty across countries using a common poverty line, a problem emanating from the sensitivity of our results to the choice of poverty line.

In the *final* instance, the analysis illuminates one of the major deficiencies of asset indices. Unlike income or expenditure, which can be relatively volatile or where mobility can be relatively rapid, asset indices are relatively slow-moving, because of the slow rate of change in the underlying asset variables. Thus, it is possible that important changes may take place in the economic situation of many households, whether for the better or for the worse, but that the asset indices would remain virtually unchanged. That being the case, our analysis cautions against using the indices constructed from asset variables to read into it short or medium term economic mobility or variability in social welfare. Moreover, the limited discrimination ability at the lower end of the scale makes the asset index a poor tool for analysing the ultra-poor. Access to water or sanitation is to a large degree not a reflection of the money-metric poverty or lack thereof of a community, but of their location in the urban-rural continuum and other factors. Hence, the asset index is far better as a crude indicator of the relative ranking of the population, within broad categories, in terms of social welfare.

For these reasons, a comparison of the general trends in poverty reported in this paper and those reported in other sources for roughly equivalent periods reveals that although many trends are confirmed, others are not. These conceptual and methodological caveats of the asset index approach to analysis of poverty is unfortunate as the available income and expenditure data for African countries often are unreliable, patchy and not directly comparable.

6. References

- Asselin, L-M., 2002. *Multidimensional poverty: Composite indicator of multidimensional poverty*. Lévis, Québec: Institut de Mathématique Gauss.
- Booyesen, F. le R., 2002. Using Demographic and Health Surveys to measure poverty: An application to South Africa. *Journal for Studies in Economics and Econometrics* 26(3): 53-70.
- Chen, S., G. Datt & Ravallion, M., 1995. *Is Poverty Increasing in the Developing World?* Washington, DC: Policy Research Department of the World Bank.
- Chen, S. & Ravallion, M., 2004. How Have the World's Poorest Fared Since the Early 1980s? *World Bank Policy Research Working Paper Series No. 3341*.
- Deaton, A., 1997. *The analysis of household surveys – a microeconomic approach to development policy*. Baltimore & London: Johns Hopkins University Press.
- Duclos, J-Y. & Araar, A., Poverty and Equity: Measurement, Policy and Estimation. Department of Economics and CIRPEE, Laval University, Canada.
- Fields, G., 2000. *Distribution and Development: A New Look at the Developing World*. MIT Press: Massachusetts.
- Filmer, D. & Pritchett, L., 1998. *Estimating wealth effects without expenditure data – or tears: An application to educational enrollments in states of India*. World Bank Policy Research Working Paper No. 1994, Washington DC: World Bank.
- Green, P.E., 1978. *Analyzing Multivariate Data*. Hinsdale, Illinois: Dryden Press.
- Greenacre, M.J., 1984. *Theory and Applications of Correspondence Analysis*. London: Academic Press.
- Republic of Kenya, 2003. *Millennium Development Goals Progress Report for Kenya*. The Government of Kenya: Ministry of Planning and National Development.

- Sahn, D.E. & Stifel, D.C., 2000. Poverty comparisons over time and across countries in Africa. *World Development* 28(12): 2123-2155.
- Sahn, D.E. & Stifel, D.C., 2003. Urban-rural inequality in living standards in Africa. *Journal of African Economies* 12: 564-597.
- Statacorp, 2003. *Stata Statistical Software: Release 8.0*. College Station, TX: Stata Corporation.
- Teal, F., 2001. *Education, incomes, poverty and inequality in Ghana in the 1990s*. CSAE Working Paper Series No. 2001-21.
- UNFPA, 2002. *State of the World Population: People, Poverty and Possibilities*. New York: UNFPA.
- UN Population Division, 2002. *World Population Prospects: The 2002 Revision*. Population Database. Online: <http://esa.un.org/unpp/p2k0data.asp> [accessed 18 May 2004].
- Van Kerm, P., 1998. Simple and multiple correspondence analysis in Stata. *Stata Technical Bulletin* 42: 210-217.
- World Bank, 2000a. *Country Reports on Health, Nutrition, Population and Poverty*. Available: <http://www.worldbank.org/poverty/health/data/intro.htm> [accessed 13 February 2001].
- World Bank, 2000b. *World Development Report 2000/2001*. Washington, DC: World Bank.
- World Bank, 2005. *World Development Indicators*. Washington, DC: World Bank.

**Appendix A: Characteristics of Demographic and Health Surveys
conducted in selected countries, and total and urban population estimates**

Country	Year	Sample (n)			Population (<i>'000</i>)	Urban population (<i>'000</i>) (Urban share)
		Households	Females	Males		
Ghana	1988	4 406	4 488	943 (h)	14 417	5 045 (35.0%)
	1993	5 822	4 562	1 302	16 580	6 407 (38.6%)
	1998	6 003	4 843	1 546	18 732	7 939 (42.4%)
Kenya	1989	8 173	7 150	1 130 (h)	22 765	5 392 (23.7%)
	1993	7 950	7 540	2 336	25 799	7 159 (27.7%)
	1998	8 380	7 881	3 407	29 244	9 769 (33.4%)
Mali	1987	3 048	3 200	970	8 377	1 850 (22.1%)
	1996	8 716	9 704	2 474	10 649	2 930 (27.5%)
	2001	12 285	12 817	3 390	12 266	3 785 (30.9%)
Senegal	1986	3 736	4 415	-	6 558	2 490 (38.0%)
	1992	3 528	6 310	1 436	7 727	3 205 (41.5%)
	1997	4 772	8 593	4 306	8 745	3 952 (45.2%)
Tanzania	1992	8 327	9 238	2 114	27 884	6 594 (23.6%)
	1996	7 969	8 120	2 256	31 608	8 817 (27.9%)
	1999	3 615	4 029	3 542	34 000	10 575 (31.1%)
Zambia	1992	6 209	7 060	-	8 650	3 333 (38.5%)
	1996	7 286	8 021	1 849	9 572	3 525 (36.8%)
	2001	7 126	7 658	2 145	10 541	3 731 (35.4%)
Zimbabwe	1988	4 107	4 201	-	9 753	2 682 (27.5%)
	1994	5 984	6 128	2 141	11 467	3 569 (31.1%)
	1999	6 369	5 907	2 609	12 461	4 140 (33.2%)

Notes: The 'h' in italics with the male sample size refers to those surveys that interviewed the husbands or partners of female respondents and did not draw a random sample of male respondents from the sampled households.

Source: www.measuredhs.com; Population data obtained by interpolation based on data from UN Population Division. 2002. *World Population Prospects: The 2002 Revision*. Population Database. Online: <http://esa.un.org/unpp/p2k0data.asp>

Appendix B: Economic and demographic characteristics of selected countries

Indicator	Ghana	Kenya	Mali	Senegal	Tanzania	Zambia	Zimbabwe
1. Population size (millions)(2001)	19.7	30.7	11.1	9.8	34.4	10.3	12.8
2. Average annual population growth (1980-2001)	2.9	1.3	2.5	2.7	2.9	2.8	2.8
3. HIV adult prevalence (2001)	3.0	15.0	1.7	0.5	7.8	21.5	33.7
4. Percentage population urbanised (2001)	36.4	34.3	30.8	48.1	33.2	39.8	36.0
5. Gross national income per capita (US\$)(2001)	290	350	230	490	270	320	480
6. Average annual GDP growth (1990-2001)	4.2	2.0	4.1	3.9	3.2	0.8	1.8
7. Percentage value added to GDP %(2000): Agriculture	35	20	41	18	45	22	18
Industry	25	19	21	27	16	25	25
Services	39	62	38	55	39	52	57
8. % population with access to improved water source (2000)	73	57	65	78	68	64	83
9. % population with access to improved sanitation (2000)	72	87	69	70	90	78	62
10. Education budget as % of GDP: 1990	3.2	6.7	N/a	3.9	3.2	2.4	N/a
1998-2000	4.1	6.4	2.8	3.2	2.1	2.3	10.4
11. Health budget as % of GDP: 1990	1.3	2.4	1.6	0.7	1.6	2.6	3.2
2000	2.2	1.8	2.2	2.6	2.8	3.5	3.1
20. Incidence of poverty (US\$1 per day)(latest available estimate)	44.8	23.0	72.8	26.3	19.9	63.7	36.0
21. Poverty gap (US\$1 per day)(latest available estimate)	27.3	6.0	37.4	7.0	4.8	32.7	9.6
22. Gini index (latest available estimate)	40.7	44.9	50.5	41.3	38.2	52.6	50.1
23. Human Development Index (HDI): 1990	0.515	0.535	0.287	0.378	0.408	0.461	0.614
2001	0.567	0.489	0.337	0.430	0.400	0.386	0.496
24. GDP per capita minus HDI ranking (2001)	-1	+14	-5	-9	+14	+7	-18
25. Gender Development Index (GDI)(2001)	0.564	0.488	0.327	0.420	0.396	0.376	0.489

Sources: 1-2, 5-7, 10-11, 20-22: World Development Indicators (2002/03); 3: UNAIDS (2002); 4, 8-9, 12-19, 23-24: Human Development Report (2003).

Appendix C: Multiple correspondence and principal components analyses

Asselin (2002: 14) describes the calculation of a composite poverty indicator using MCA:

A composite indicator of multiple quality poverty indicators, defined as a set of categories, for different population units, is given by: [a] computing the profile of the population unit relative to these primary indicators, and [b] applying to this profile the category-weights given by the normalized scores of these indicators on the first factorial axis coming out of the multiple correspondence analysis of the indicators.

A population unit's MCA composite poverty indicator score (hereafter referred to just as its 'score') is calculated by adding up all of that unit's weighted responses.

Figure C: MCA data matrix form

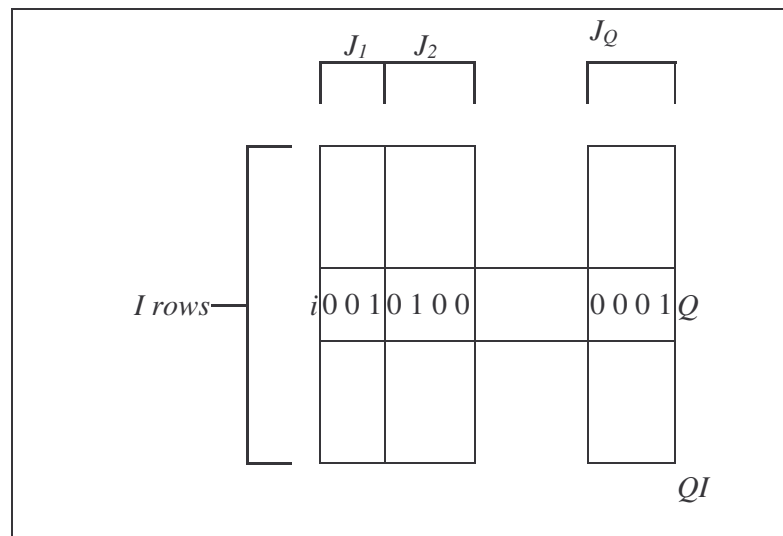

Source: Greenacre (1984: 138).

We have to define the terms profile and normalisation. First of all, the row profiles of a matrix are the rows of that matrix, each divided by its row sum. Similarly, the column profiles are the columns divided by the respective column sums. The term profile in Asselin's definition refers to either the row or column profiles, since it can be shown that MCA on the rows of a matrix is equivalent to MCA on that matrix's columns (the standardised MCA coordinates are equivalent in both cases). The method used in this paper does not specifically apply MCA to the data matrix (of the form of Figure C), but rather applies a method synonymous to MCA on the survey data matrix, i.e. correspondence analysis (CA) on the Burt matrix that is calculated from the original survey data matrix. The Burt matrix of an indicator matrix (Figure C) is simply the indicator matrix transposed and post-multiplied by itself. Applying CA on the Burt matrix calculated from a data matrix is equivalent to applying MCA on the columns of that original data matrix (Greenacre, 1984). The normalization referred to in the introduction is the method of taking

each column of a data matrix, subtracting from these their column means and then dividing them (i.e. each element in each column) by their respective column standard deviations.

The PCA process is similar, except the PCA weights are the category loadings in the first principal component arising from PCA (un-rotated factor analysis), and these category-weights are then applied to the normalised responses of the population unit. That population unit's score is then the sum of that unit's weighted normalised responses. A population unit's score serves as a relative measure of poverty for that unit, relative to all the population units in the analysis, or more technically, relative to all the units used in the calculation of the weights.

A distinction we have to make when applying MCA and PCA to the same data is the structure of the survey data matrix underlying the multivariate analysis. For MCA, we need a matrix of the form of Figure C above. In this matrix there are Q questions, J_q categories for question q , and J categories in total. The important distinction to be made in this matrix, compared to that of the PCA, is that each population unit (or row) has to answer 'yes' or '1' to one category in every question, i.e. the categories represent all possible answers for question q . This forces every row in the matrix to have a total of Q . The matrix used in the PCA is similar, but the redundant category for each question is left out of the analysis.

For a more comprehensive description of multiple correspondence analysis (MCA), see Greenacre (1984). For a detailed discussion of principal component analysis (PCA), consult Green (1978).



International Poverty Centre

SBS – Ed. BNDES, 10º andar
70076-900 Brasilia DF
Brazil

povertycentre@undp-povertycentre.org
www.undp.org/povertycentre
Telephone +55 61 2105 5000